

GENERAL DESCRIPTION

FUNCTIONAL PRINCIPLE

The proximity-action capacitive sensor converts a variable of interest in technical production terms (e.g. distance or level) into a signal which can be processed further. The function is based on the alteration in the electrical field around its active zone.

The sensor in its basic configuration consists of an oscillator as pick-up, a demodulator, and an output stage.

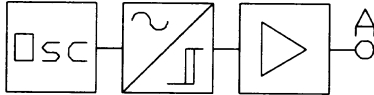

Figure 1.01

The approach of metals or non-metals into the active zone of the capacitive sensor causes a change in capacitance, which in turn causes the oscillator to begin to vibrate. This causes the trigger stage downstream of the oscillator to flip, and the switching amplifier to change its output status. The switching function at the output is either normally open (NO) or normally closed (NC), depending on the type of unit involved.

The function of the capacitive sensor can be explained in terms of variation in all parameters of the equation for capacitance:

$$C = E_o \times E_r \times F \times S / (1/S)$$

E_r : as the relative dielectric coefficient
(Property of the medium being scanned)

E_o : as absolute dielectric coefficient
(constant)

F: as surface

S: as distance

From the formula above, it follows that objects which have a sufficiently large relative dielectric coefficient (E_r) and surface will be detected by the capacitive sensor.

Our capacitive sensors contain an oscillator as the pick-up component, backed up by the evaluation electronics (switching amplifier and output stage).

We manufacture capacitive sensors in 2 different versions:

1. Mini Series: (separate sensor and amplifier)

Here it is only the oscillator or capacitive pick-up which is accommodated in the sensor housing. The electronics are located in a separate housing. The sensor can be separated from the electronics.

2. Self-Contained Sensor:

Here the sensor and the amplifying electronics are accommodated in one sensor housing.

APPLICATION

The capacitive proximity switches are suitable as non-contact sensors for controlling and monitoring machine processes and as primary detectors for counting jobs, where metals and non-metals are available; for level messages in tanks and through tank walls, in cases where liquid, pulverized or granular substances have to be detected. There are two types of applications for capacitive sensors:

1. Flush installation:

Sensors with a straight-line electrical field scan solids (e.g. wafers, components, PCB's, hybrids, cartons, paper piles, bottles, plastic blocks and plastic plates) at a distance, or liquids through a separating wall (glass or plastic up to max. 4 mm thick).

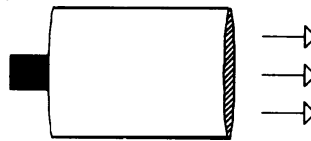

Figure 1.02

2. Non-flush installation:

Sensors with a spherical electrical field are designed to touch the product, bulk goods or liquids involved (e.g. granulate, sugar, flour, corn, sand, or oil and water) with their active surface.

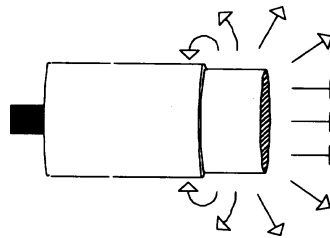

Figure 1.03

SENSING DISTANCE (S)

This is the distance between the active sensor surface and the product being scanned at the moment of output-signal change as the object is approached. It depends on shape, size and nature of the object concerned.

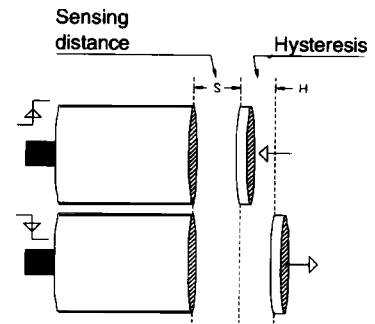

Figure 1.04

HYSTERESIS

Hysteresis is the distance differential between the switch-on point (as the object approaches) and the switch-off point (as the object recedes again).

REPRODUCIBILITY

The reproducibility parameter describes the maximum deviation from the sensing distance when the object in question is approached several times.

RATED SENSING DISTANCE(Sn)

The rated sensing distance is the usable sensing distance of the sensor when directed at the metal plate. The edge length of the metal plate corresponds to the diameter of the active sensor surface. The catalogue particular "Sensing distance (Sn)" expresses the maximum usable distance for a sensor type in relation to the metal plate mentioned above. If the plate is made from a different material or has a smaller diameter, the maximum usable sensing distance will be reduced. For objects of different sizes, shapes or nature, the rated sensing distances will be shorter.

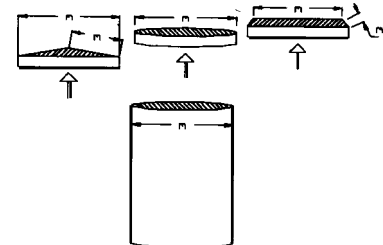

Figure 1.05

GENERAL DESCRIPTION

SIZE CORRECTION FACTOR

For objects which are not flat and are smaller in relation to the active sensor surface, the following sensing distances are obtained in dependence on the scaled object surface

F/F_0 , where:

F_0 = sensor front surface (active surface), and F = front surface of the object being scanned.

The figures in the table Figure 1.06 refer to flush sensors, and objects in the form of long thin rods.

Scaled object surface F/F_0 mm	Sensing distance S in mm		F in mm	S in mm^2
	in %			
1.50	100	22	380	8.0
1.24	100	20	314	8.0
0.80	100	16	201	8.0
0.61	100	14	154	8.0
0.31	94	10	79	7.5
0.20	85	8	50	6.8
0.15	82.5	7	38	6.6
0.05	67.5	4	13	5.4
0.03	57.5	3	7	4.6

Figure 1.06

The three right-hand columns of Figure 1.06 reflect the application example for an LCA-M5-1-F sensor.

RESPONSE CURVE

Figure 1.07 shows a typical response curve. The response curves for our capacitive sensors depend on the adjusted sensing distance, and on the properties of the object being scanned. In order to standardize the depiction, all curves are with reference to a control lug made of ST 37, and are drawn as limit characteristics for the rated sensing distance (S_n) and ($S_n/2$).

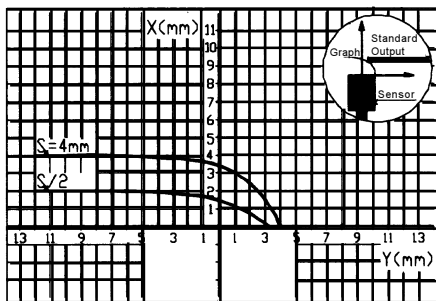

Figure 1.07

MATERIAL CORRECTION FACTOR

If the material of the object in question is not metal or water, the rated sensing distance (S_n) is reduced. The reduction factors for the different materials are given in the table below.

Material	Thickness d / mm	E_r	Reduction factor
Steel ST-37	1.5		1.0
Brass Ms	1.5		1.0
Water		app. 81	1.0
Mikanit 132	2	4.5	0.44
	4		0.52
	6		0.57
UP (Polyester, glass-fiber-reinforced)	2	4.0	0.41
	4		0.51
	6		0.54
Polyamide A (nylon 6.6)	2	4.2 atm. humidity	0.34
	4		0.45
	6		0.51
Polyamide B (Nylon 6)	3	5.3 atm. humidity	0.41
	6		0.48
	9		0.56
Melamin Fabric-base laminate	2	7	0.53
	4		0.62
	6		0.66
Paper-base laminate	2	5	0.56
	4		0.62
	6		0.68
Polystyrene (PS)	2	2.5	0.24
	4	DIN53483	0.31
	6		0.36
Poly-carbonate (PC)	2	2.92	0.26
	4	DIN53484	0.36
	6		0.40
Polymethyl-methacrylate	5	2.9	0.39
	10	DIN53483	0.45
	15		0.47
Polyvinyl chloride	6	2.9	0.41
	12		0.47
PVC foamed	3	1.5 - 2.5	0.22
	6		0.25

Figure 1.08

HOUSING MATERIALS

The following housing materials are standards for the capacitive sensors:

PVC	Polyvinyl Chloride
PTFE	Polytetrafluoroethylene
PUR	Polyurethane
MS	Brass, chrome steel
V2A	Stainless Steel

The housing for the amplifiers and downstream devices are made of Duroplast Type selection and combination of the housing materials, almost all environmental factors are covered.

MOUNTING TYPES

Three different mounting options are available. These options are depicted in Figures 1.09, 1.10 and 1.11. Each mounting option begins with a symbol that is used later in this catalog to identify which mounting option is appropriate for each sensor.

◆ Installation type, flush

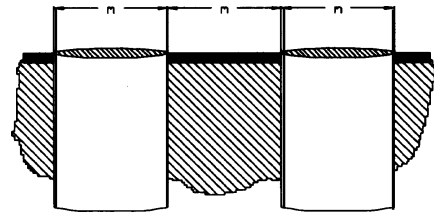

Figure 1.09

● Installation type, non-flush

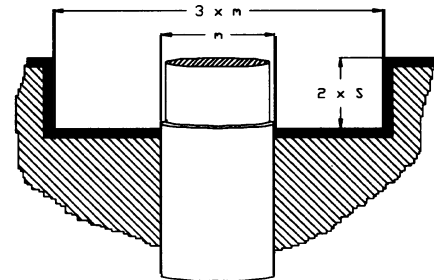

Figure 1.10

■ Installation type, non-flush

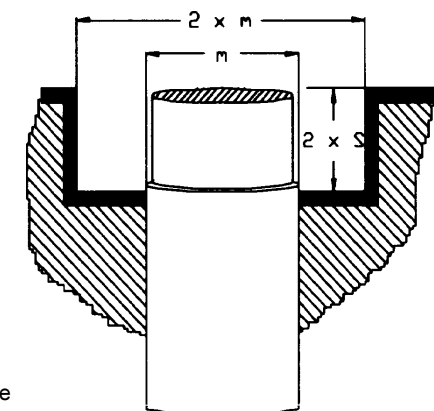

Figure 1.11

GENERAL DESCRIPTION

MOUNTING TORQUES

To ensure that the sensors are not mechanically destroyed during installation, make sure that you comply with the following torque figures.

Housing made of metal, approximately:

M5 x 0.5/V2A	3 Nm
M8 x 1/V2A	15 Nm
M12 x 1/V2A	40 Nm
M12 x 1/MS	10 Nm
M18 x 1/V2A	60 Nm
M18 x 1/MS	25 Nm
M30 x 1.5/VSA	90 Nm
M30 x 11.5/MS	65 Nm

WIRE IDENTIFICATION

The wires are color-coded in order to prevent connection errors.

DC-units:

brown = +
blue = -
black = signal

AC-units:

black or brown = L1
blue = N
green/yellow = ground

DESCRIPTION OF TERMS:

IP Degree of Protection:

The degrees of protection IP 20, IP 40, IP 54, IP 65, IP 67 are in accordance with DIN 40 050.

Code letters **IP** (International Protection) designate protection against shock hazard, ingress of solid foreign bodies, and water, for electrical equipment.

1st digit:

2 = protection against penetration of solid foreign bodies larger than 12 mm, shielding for fingers or similar objects.

4 = protection against penetration of solid bodies larger than 1 mm, shielding from tools or wires.

5 = protection against harmful dust deposits, complete shock-hazard protection.

6 = protection against penetration of dust, complete shock-hazard protection.

2nd digit:

0 = no special protection

4 = protection against water spraying from all direction against the piece of equipment concerned.

5 = protection against the water jet from a nozzle, directed from all directions against the piece of equipment concerned.

7 = protection against water, when the piece of equipment concerned (housing) is immersed in water under specified pressure and time conditions.

Please note:

The adjustment of the capacitive sensors is fitted with an M3 x 4 screw plug, thus providing degree of protection IP 67.

Standby Current:

This is the current the sensor consumes at maximum supply voltage without a connection load and LED.

Supply Voltage:

This is the voltage range in which proper functioning of the sensor is ensured.

Residual Ripple:

This is the maximum permissible AC voltage which may be superimposed on the supply voltage without affecting the function of the sensor.

Output Current:

This is the maximum current with which the sensor may be stressed in continuous operation at its output.

The minimum loading is the lowest switching capacity for AC sensors, and is essential for proper functioning.

Short-Circuit Protection and Overload Protection:

The sensors normally contain this protective feature. In the event of overload or short-circuit at the output, the output transistor is automatically switched off. As soon as the malfunction has been corrected, the output stage is reset to normal functioning.

Polarity Reversal Protection:

The sensor electronics are protected against possible polarity reversal or

interchanging of the connection wires.

EMC Protective Circuit:

Appropriate measures in the supply voltage line ensure that interference voltages are decoupled.

Ambient Temperature:

This specifies the temperature range in which the sensor may be operated without the housing being damaged or the sensor electronics failing.

Temperature Coefficient:

This states the amount by which the sensing distance changes in dependence on temperature.

SWITCHING FUNCTION

NO (Normally Open) contact:

the switching output of the sensor is not switched through in its de-activated state.

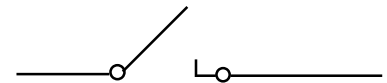

Figure 1.12

NC (Normally Closed) contact:

the switching output of the sensor is switched through in its de-activated state



Figure 1.13

CALIBRATION - CAPACITIVE SENSORS

IMPORTANT:

When calibrating capacitive sensors, the different material properties of the scanned product must be taken into consideration. Capacitive sensors are therefore equipped with potentiometers which can be trimmed to adjust the sensitivity of the device.

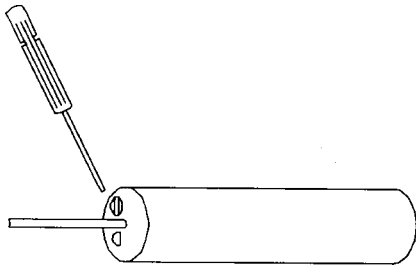

Figure 1.14

Sensitivity is increased by turning the potentiometer clockwise.

Sensitivity is decreased by turning the potentiometer counterclockwise.

SENSORS FOR FLUSH MOUNTING:

Normally, the linear field of flush sensors scans block material for distance. In order to obtain the faultless switching of sensors, check the maximum switching gap as described below before putting the device into operation:

1st example:

A ceramic plate is to be scanned. First set the sensor to the maximum switching gap S_n of 4 mm (specified in catalog) over steel or hand using the sensor amplifier (Fig. 1.15). After setting a gap of 4 mm, move the sensor over the ceramic plate. The result will be that the scanning distance over the ceramic plate will decrease to approximately 2 mm (Fig. 1.16).

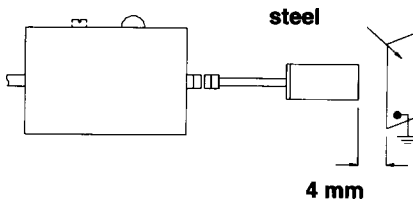

Figure 1.15

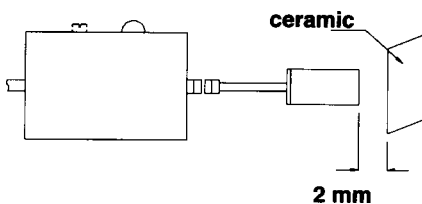

Figure 1.16

The distance of 2 mm is not the maximum switching gap on the ceramic plate.

Optimum switching is ensured if the sensor scans the ceramic plate under 2 mm and the calibration is not exceeded.

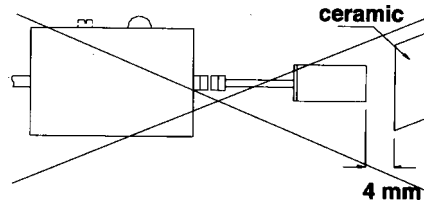

Figure 1.17

So that our sensors operate reliably within their technical specifications, they are set to a greater switching gap than the rated switching gaps (S_n) specified in the catalog. If the operator increases the switching gap to 4 mm over ceramic plate as described above, the sensor will be operating in an impermissible range (Fig. 1.17). This might lead to the risk of faulty switching in the sensor due to temperature effects and voltage transients in the power source.

2nd example:

A liquid (e.g. water) is to be scanned through a partition wall by a flush sensor. The partition wall may only be made of glass or plastic and may have a maximum thickness of 4 mm. Basically, to calculate the wall thickness, the thickness in mm will be 10 to 20 percent of the switching gap of the sensor but maximum 4 mm.

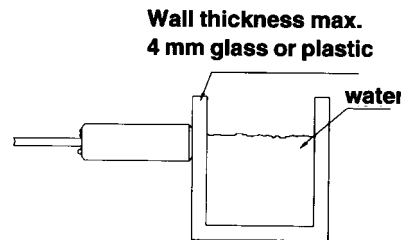

Figure 1.18

The face (active surface) of the sensor is bonded to the glass or plastic wall. The vessel is then filled with water until approximately 75 percent of the active surface of the sensor is covered.

Then turn the potentiometer of the sensor counterclockwise (decrease sensitivity) until the LED and the output signal switches off.

Then turn the potentiometer clockwise (increase sensitivity) until the LED and the output signal switches on again.

Using the calibration process described here ensures that the sensor does not

detect the wall or the water residue on the wall.

It only switches when the liquid has reached the 75 percent level described above.

SENSORS FOR NON-FLUSH MOUNTING

Due to their spherical fields, these capacitive sensors are suitable for applications as filling level indicators for plastic granulate or powder.

Example:

A granulate in a vessel is to be scanned by a non-flush mounted sensor. The sensor is mounted so that its active surface (free zone at head) projects into the product in the vessel. As depicted in Fig. 1.19, the sensor must be completely covered by the product before calibration can proceed.

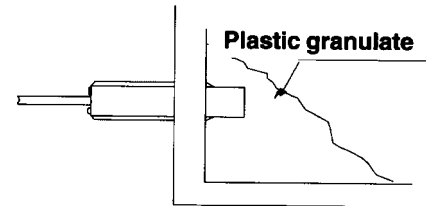

Figure 1.19

Turn the potentiometer of the sensor counterclockwise (decrease sensitivity) until the LED and the output signal switches off.

Then turn the potentiometer clockwise (increase sensitivity) until the LED and the output signal switches on again. At this point, make an additional 1/4 turn (90°) in the clockwise direction. This is in case of temperature fluctuations or changes in the humidity of the product scanned.